



EGHV-531 HVLP SPRAY GUN (SPRAY PISTOL)

Important: Before using this equipment, read all safety precautions and instructions. Keep for future use.

DESCRIPTION

The EGHV-531 HVLP spray gun is designed to be in compliance with rules issued by South Coast Air Quality Management District (SCAQMD) and other air quality authorities.

Note

All wetted surfaces are stainless steel and may be used with materials formulated with chlorinated solvents. A list of materials used in the construction of this equipment is available upon request.

SPECIFICATIONS

Air Inlet	1/4" NPS (M)
Fluid Inlet	1/4" NPS (M)
Type Feed	Suction or Pressure
Air Consumption 8.8 cfm at 50 psi (249 liters/min. at 3.5 bar)	Inlet Cap Press. 50 psi (3.5 bar) 10 psi (.7 bar)

OPERATION

Prepare and strain material according to the paint manufacturer's instructions. Attach container to fluid inlet (24) and tighten. Adjust incoming air pressure to gun to approximately 50 psi (3.5 bar or less). Use clean, dry air and adjust inlet air pressure to obtain a maximum of 10 psi (.7 bar) reading on GA-357 gauge (part of Air Cap Test Kit, see Accessories).

Note

Only use as much pressure as required to atomize material.

EGHV can be used for pressure feed application. Replace attached container with fluid hose of proper size and construction to a remote supply. Adjust fluid pressure to deliver the desired amount of material that can be atomized at 10 psi (.7 bar) cap pressure or less.

PREVENTIVE MAINTENANCE

To clean fluid passages, remove excess material at source, then flush with a suitable solvent.

To clean air cap and fluid tip, brush with a stiff bristle brush. If necessary, use a broom straw or toothpick. Never use a wire or hard instrument. This may scratch or burr holes causing a distorted spray pattern.

If performance problems develop, orifices could be plugged or contaminated from the air supply or other sources. These orifices are sized and tuned to

provide 10 psi (.7 bar) to air cap horn and center air independently.

Procedure: Attach air cap test kit and adjust pressure at inlet to 50 psi (3.5 bar) with trigger depressed. Air cap test kit gauge should read 10 psi + 0 -1 psi (.7 bar + 0 - .1 bar). If pressure varies more than 10%, clean orifices using the following procedures. Remove tip (5), baffle (air distributor) (6) and air valve (18) and blow air back through the orifice to clear blockage. Reassemble. See Figure 1.

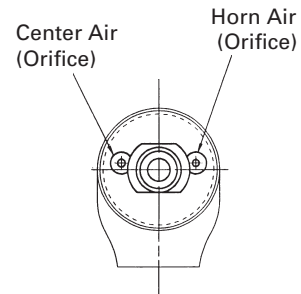

Figure 1 (Facing front of gun with tip removed)

LUBRICATION

For best results, lubricate the points indicated in Figure 2 daily using SSL-10 Gun Lube. See Accessories.

- A. Trigger points
- B. Packings
- C. Adjusting valves
- D. Needle – Air valve springs (occasionally)

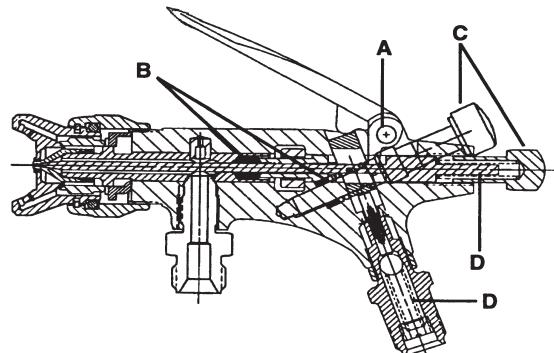

Figure 2

■ Government NSN No. 4940-01-182-697 = KK-5044

IMPORTANT! DO NOT DESTROY

It is the Customer's responsibility to have all operators and service personnel read and understand this manual. Contact your local DeVilbiss representative for additional copies of this manual.

READ ALL INSTRUCTIONS BEFORE OPERATING THIS DEVILBISS PRODUCT.

SAFETY PRECAUTIONS

This manual contains information that is important for you to know and understand. This information relates to USER SAFETY and PREVENTING EQUIPMENT PROBLEMS. To help you recognize this information, we use the following symbols. Please pay particular attention to these sections.



Important safety information – a hazard that may cause serious injury or loss of life.







Important information that tells how to prevent damage to equipment, or how to avoid a situation that may cause minor injury.

Note

Information that you should pay special attention to.



The following hazards may occur during the normal use of this equipment. Please read the following chart.

HAZARD	CAUSE	SAFEGUARDS
<p>Fire</p> 	<p>Solvents and coatings can be highly flammable or combustible, especially when sprayed.</p>	<ol style="list-style-type: none"> 1. Adequate exhaust must be provided to keep the air free of accumulations of flammable vapors. 2. Smoking must never be allowed in the spray area. 3. Fire extinguishing equipment must be present in the spray area. 4. Static discharges must be prevented. Ground (earth) all conductive objects in the spray area, such as a cleaning solvent bucket, fire extinguisher, etc. 5. When using solvents for cleaning: <ul style="list-style-type: none"> • Those used for equipment flushing must have a flash point equal to or higher than that of the coating. • Those used for general cleaning must have flash points above 100°F (37.8°C).
<p>Solvent Spray</p> 	<p>During cleaning and flushing, solvents can be forcefully expelled from fluid and air passages. Some solvents can cause eye injury.</p>	<p>Wear eye protection</p>
<p>Inhaling Toxic Substances</p> 	<p>Certain materials may be harmful if inhaled or if there is contact with the skin.</p>	<ol style="list-style-type: none"> 1. Follow the requirements of the Safety Data Sheet supplied by your coating manufacturer. 2. Adequate exhaust must be provided to keep the air free of accumulations of toxic materials. 3. Use a mask or respirator whenever there is a chance of inhaling sprayed materials. The mask must be compatible with the material being sprayed and its concentration.
<p>General Safety</p>	<p>Improper operation or maintenance of equipment.</p>	<p>Operators should be given adequate training in the safe use and maintenance of the equipment (in accordance with the requirements of NFPA-33, Chapter 15 in U.S.). Users must comply with all local and national codes of practice and insurance company requirements governing ventilation, fire precautions, operation, maintenance and housekeeping (in the U.S., these are OSHA Sections 1910.94 and 1910.107 and NFPA-33).</p>
<p>Explosion Hazard – Incompatible Materials</p> 	<p>Halogenated hydrocarbon solvents, for example: methylene chloride and 1,1,1, - Trichlorethylene, are not chemically compatible with the aluminum that might be used in many system components. The chemical reaction caused by these solvents reacting with aluminum can become violent and lead to an equipment explosion.</p>	<p>This spray gun (spray pistol) can be used with these solvents. However, aluminum is widely used in other spray application equipment - such as material pumps, regulators, valves, etc. Check all other equipment items before use and make sure they can also be used safely with these solvents. Read the label or data sheet for the material you intend to spray. If in doubt as to whether or not a coating or cleaning material is compatible, contact your material supplier.</p>

PARTS LIST

Ref. No.	Replacement Part No.	Description	Individual Parts Req.
1	EGA-4	Packing Nut	1
■ 2	55-846-5	Needle Packing (Kit of 5)	1
3	EGHV-439-397HV	Air Cap with Ring	1
4	EGA-7	Baffle (air distributor)	1
5	EGA-4000-E	Tip, Needle & Gasket Assy.	1
6	EGA-59-K5	Gasket (Kit of 5) (Polyethylene)	1
7	EGA-443	Trigger & Stud Assy.	1
■ 8	AG-3-1-K5	Trigger Bearing Stud (Kit of 5)	1
■ 9	EGA-5-K6	Air Valve Plunger (Kit of 6)	1
10	EGA-454	Fan Adjustment Assy. - Horn	1
■ 11	SSG-8205-K10	O-Ring (Kit of 10)	1
■ 12	AG-26-K10	Washer (Kit of 10)	2
■ 13	---	Spring	1
14	EGA-3	Packing Gland	1

Ref. No.	Replacement Part No.	Description	Individual Parts Req.
15	---	Fluid Needle (included in Item 5)	1
■ 16	AG-7-K5	Needle Spring (Kit of 5)	1
17	AG-16	Needle Adj. Screw	1
18	EGA-441	Air Valve Assy.	1
19	AG-46-K3	Lock Nut (Kit of 3)	1
■ 20	EGA-9-K5	Stem (Kit of 5)	1
■ 21	SST-3008-K5	Ball (Kit of 5)	1
■ 22	---	Spring	1
23	GD-36-K5	Spring Retainer (Kit of 5)	1
24	EGHV-3	Fluid Adapter	1
25	EGHV-453	Gun Body Assy.	1

■ A necessary quantity of parts is included in Gun Repair Kit KK-5044.

Government NSN No. 4940-01-182-697 = KK-5044

Suffixes -K3, -K5, etc. designates kits of multiple parts.
Example: EGA-59-K5 is a kit of (5) seals.

WARRANTY



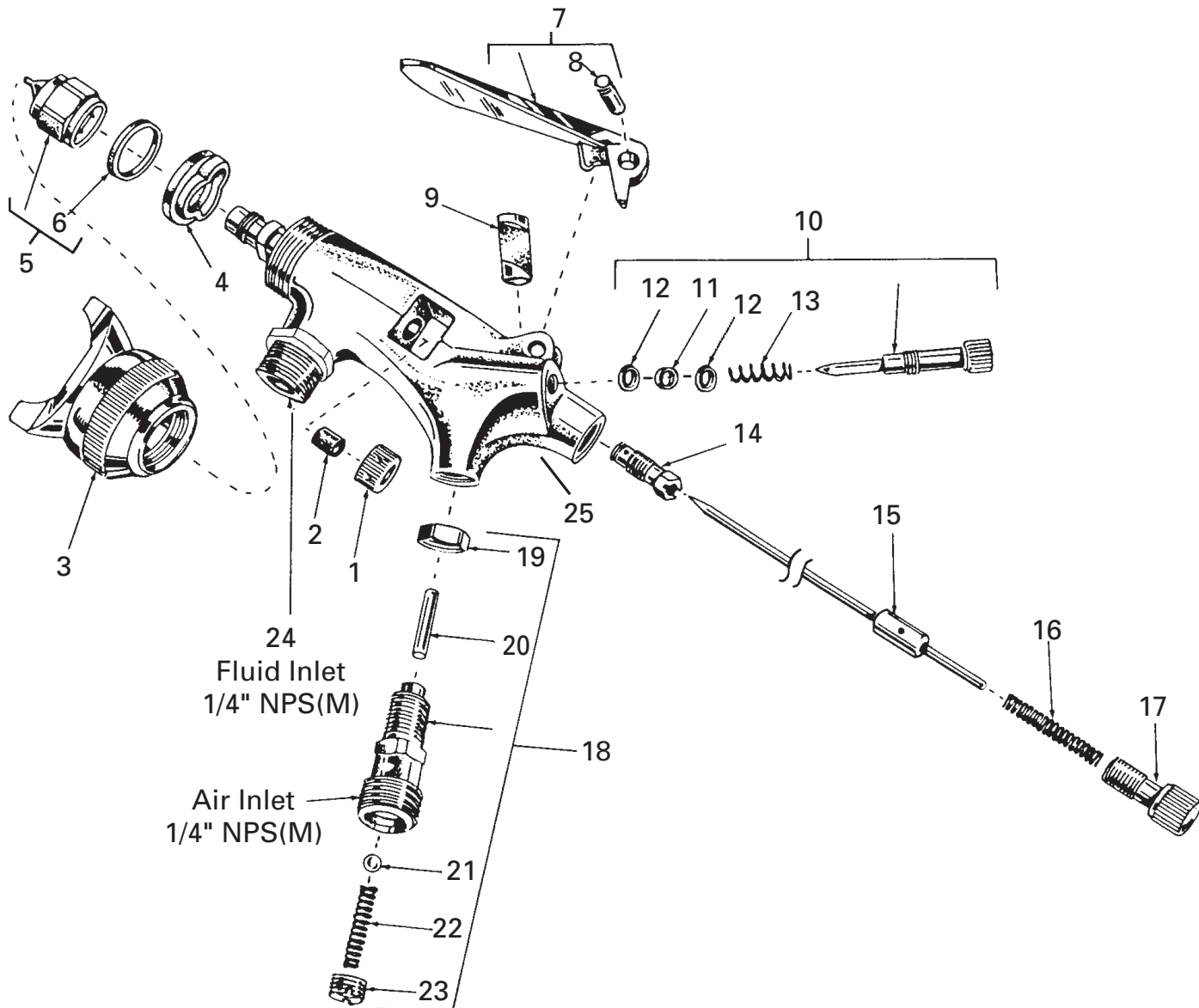

This product is covered by DeVilbiss' 1 Year Limited Warranty. See SB-1-000 which is available upon request.

NOTE

For Europe, this will not affect the purchasers statutory rights, for example, under the U.K. Consumer Protection Act.



TROUBLESHOOTING

CONDITION	CAUSE	CORRECTION
Heavy top or bottom pattern 	Horn holes plugged. Obstruction on top or bottom of fluid tip. Cap and/or tip seat dirty.	Clean. Ream with non-metallic point. Clean. Clean.
Heavy right or left side pattern 	Left or right side horn holes plugged. Dirt on left or right side of fluid tip. Remedies for top-heavy, bottom-heavy, right-heavy and left-heavy patterns: 1) Determine if obstruction is on cap or fluid tip. Do this by making a test pattern. Then, rotate cap one-half turn and spray another pattern. If defect is inverted, obstruction is on air cap. Clean air cap as previously instructed. 2) If defect is not inverted, it is on fluid tip. Check for a fine burr on edge of fluid tip. Remove with #600 wet or dry sand paper. 3) Check for dried material just inside opening. Remove by cleaning.	Clean. Ream with non-metallic point. Clean.
Heavy center pattern 	Material flow exceeds air cap's capacity. Atomizing pressure too low. Material too thick.	Thin or lower fluid flow. Increase pressure. Thin to proper consistency.
Split spray pattern 	Fluid adjusting knob turned in too far. Atomization air pressure too high.	Back out counterclockwise to achieve proper flow. Reduce air pressure.
Jerky or fluttering spray 	*Loose or damaged fluid tip/seat. Material level too low. Container tipped too far. Obstruction in fluid passage. Loose or broken fluid tube or fluid inlet nipple. Dry or loose needle packing nut.	Tighten or replace. Refill. Hold more upright. Clean according to material supplier's recommendations. Tighten or replace. Lubricate or tighten.
Will not spray	No air pressure at gun. Needle adjusting screw not open enough.	Check air supply and air lines. Open needle adjusting screw.
Excessive overspray (spray mist)	Too much atomization air pressure. Gun too far from work surface. Improper stroking (arching, gun motion too fast). Gun out of adjustment.	Reduce pressure. Adjust to proper distance. Move at moderate pace, parallel to work surface. Adjust.
Fluid leaking from packing nut	Packing nut loose. Packing worn or dry.	Tighten, do not bind needle. Replace or lubricate.
Fluid leaking or dripping from front of gun	*Foreign matter in tip. Packing nut too tight. Dry packing. Fluid tip or needle worn or damaged. Needle spring deformed or broken.	Clean. Adjust. Lubricate. Replace tip & needle with lapped sets. Replace.
Runs and sags	Too much material flow. Material too thin. Gun tilted at an angle.	Adjust gun or reduce fluid pressure. Mix properly or apply light coats. Hold gun at right angle to work and adapt to proper gun technique.
Thin, sandy coarse finish. Drying before it flows out	Gun too far from surface. Too much air pressure. Improper thinner being used.	Check distance. Normally 6-8" (152-203 mm). Reduce air pressure and check spray pattern. Follow paint mfg's mixing instructions.
Thick, dimpled finish (orange peel). Too much material	Gun too close to surface. Air pressure too low. Improper thinner being used. Material not properly mixed. Surface rough, oily, dirty.	Check distance. Normally 6-8" (152-203 mm). Increase air pressure or reduce fluid pressure. Follow paint manufacturer's mixing instructions. Follow paint manufacturer's mixing instructions. Properly clean and prepare.
Excessive fog	Too much, or too fast-drying thinner. Too much atomization air pressure.	Remix properly. Reduce pressure.
Unable to get round spray	Fan adjustment screw not seating right. Air cap retaining ring (nut) loose.	Clean or replace. Tighten.

* Most common problem.

ACCESSORIES

**P-H-5516
Air Adjusting Valve**

Enables user to control and reduce air usage at the gun. Ideal for low pressure spraying.

**42884-214-K5 3/8"
42884-215-K10 5/8"
Cleaning Brushes**

These brushes are helpful in cleaning threads and recesses of gun body. Available in U.S. only.

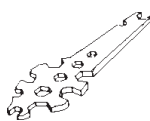
WR-103 Wrench

Contains all necessary tip, hose and nut sizes used on or with gun. Available in U.S. only.

TGS Cups

TGS-503 polyethylene 8 ounce (240 ml) suction feed cup.

**Gun Lube
SSL-10-K12
(2 oz. (60 ml) bottle)**

Compatible with all paint materials: contains no silicone or petroleum distillates to contaminate paint.

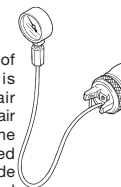
**Air Cap Test Kit KK-5043
(397HV Air Cap)**

The purpose of this test kit is to measure air cap atomizing air pressure at the air cap. Used to confirm code compliance and as a daily quality control measure.

**Scrubs® Hand Cleaner Towels
29-3100**

Scrubs® are a pre-moistened hand cleaner towel for painters. No water is needed.

NOTES

WARRANTY POLICY

This product is covered by Carlisle Fluid Technologies' materials and workmanship limited warranty. The use of any parts or accessories, from a source other than Carlisle Fluid Technologies, will void all warranties. Failure to reasonably follow any maintenance guidance provided may invalidate any warranty.

For specific warranty information please contact Carlisle Fluid Technologies.

For technical assistance or to locate an authorized distributor, contact one of our international sales and customer support locations.

Region	Industrial / Automotive	Automotive Refinishing
Americas	Tel: 1-800-992-4657 Fax: 1-888-246-5732	Tel: 1-800-445-3988 Fax: 1-800-445-6643
Europe, Africa, Middle East, India	Tel: +44 (0)1202 571 111 Fax: +44 (0)1202 573 488	
China	Tel: +8621-3373 0108 Fax: +8621-3373 0308	
Japan	Tel: +81 45 785 6421 Fax: +81 45 785 6517	
Australia	Tel: +61 (0) 2 8525 7555 Fax: +61 (0) 2 8525 7575	

For the latest information about our products, visit www.carlisleleft.com

Carlisle Fluid Technologies is a global leader in innovative finishing technologies. Carlisle Fluid Technologies reserves the right to modify equipment specifications without prior notice.

BGK™, Binks®, DeVilbiss®, Hosco®, MS®, and Ransburg® are all registered trademarks of Carlisle Fluid Technologies, Inc.

©2020 Carlisle Fluid Technologies, Inc.
All rights reserved.

