

BINKS®

EXTENSIONS

CATALOG

Conventional
HVLP
Airless
Specialty Applications



USE GENUINE BINKS SPRAY GUN EXTENSIONS

BINKS®

www.binks.com





EXTENSION INDEX

Extension Type	Use	Page
Conventional Circular Spray Extensions		
"C" Extension	Extension for inside of 3" to 24" Pipe (Medium Viscosity Materials)	3
"SC" Extension	Extension for inside of 3/4" to 12" Pipe (Thin Viscosity Materials)	4
"HC" Extension	Extension for inside of 3" to 24" Pipe (Heavy Viscosity Materials)	5
"HCVT" Extension	Extension for inside of 3" to 24" Pipe (Heavy Viscosity Abrasive Materials)	6
"SCMBX" Extension	Extension for inside of 3/4" to 12" Pipe (Fine Atomization Thin Viscosity Materials)	7
52-2410	Flexible Extension for inside areas that a rigid extension cannot reach	8
52-1382 (52-3511)	Extension for inside of 3" to 24" Pipe (Medium Viscosity Materials) (52-3511 for heavy materials)	9
Conventional Forward Spray Extensions		
"EA" Extension	Forward Fan Spray - Extended Reach (uses standard 60 series fluid nozzles and air caps)	10
"EAX" Extension	Forward Fan Spray - Extended Reach (uses small diameter air cap and fluid nozzles)	11
"SA" Extension	Forward Spray Round Spray - Extended Reach (fits through 7/16" clearance hole)	12
Conventional 45 Degree Spray Extensions		
"EN" Extension	45 Degree Fan Spray - Extended Reach (uses standard 60 series fluid nozzles and air caps)	13
"ENX" Extension	45 Degree Fan Spray - Extended Reach (uses small diameter air cap and fluid nozzles)	14
"ERX" Extension	45 Degree Reverse Fan Spray - Extended Reach (uses small diameter air cap and fluid nozzles)	15
Conventional 90 Degree Spray Extensions		
"EB" Extension	90 Degree Fan Spray - Extended Reach (uses standard 60 series fluid nozzles and air caps)	16
"EBX" Extension	90 Degree Fan Spray - Extended Reach (uses small diameter air cap and fluid nozzles)	17
Extensions for HVLP Guns		
HVLP	HVLP Extensions For Mach Series guns uses standard 90 series fluid tips and air caps	18
54-5600	HVLP Extensions For Mach Series guns (3 fan patterns for interior surfaces)	19
Airless High Pressure Spray Extensions		
AIRLESS 1 EXTENSIONS	High pressure extensions for Airless 1 guns or guns with 3/4"-20 Thread.	20
AIRLESS 75 EXTENSIONS	High pressure extensions for Airless 75 Guns or guns with a 7/8"-14 Thread	21
Specialty Spray Extensions		
RUSTPROOFER	Used with conventional guns to spray internal surfaces for rustproofing	22
CLEANING EXTENSION	Used with conventional guns to spray water or solvents for cleaning parts	23
EXTENSION ARM	Guns attached to front of arm - used to extend reach	24
Part Sheet and Service Information		
		25





BINKS CONVENTIONAL SPRAY GUN EXTENSION STYLE "C"



- * Used to coat the inside diameter of 2" to 24" pipe.
- * Needs to be pressure fed from a pressure tank, pump or pressure cup.
- * 360 degree spray pattern
- * Forward angle, forward angle/forward spray, right angle or reverse angle tip (specify when ordering).
- * Fits through a 3/4" clearance hole.
- * Best suited for thin/medium to medium/heavy viscosity materials.
- * Long needle shuts material off at the tip.
- * Useable length of extension is approximately 1-1/2" shorter that extension length.



52-365 Tip
Forward angle



52-363 Tip
Right angle





52-364 Tip
Reverse angle



52-1621-1
Forward Angle
Forward Spray

Extension Part Number chart for the following Binks Conventional Spray guns

Model  Length 	2001 , 2100 or 2101	95	95A or 95AR	21	Trophy Hand	Trophy Auto
6"	52-404	52-3885	52-3897	52-392	152-3885	152-3897
9"	52-405	52-3886	52-3898	52-393	152-3886	152-3898
12"	52-406	52-3887	52-3899	52-394	152-3887	152-3899
15"	52-407	52-3888	52-3900	52-395	152-3888	152-3900
18"	52-408	52-3889	52-3901	52-396	152-3889	152-3901
24"	52-409	52-3890	52-3902	52-397	152-3890	152-3902
30"	52-410	52-3891	52-3903	52-398	152-3891	152-3903
36"	52-411	52-3892	52-3904	52-399	152-3892	152-3904
48"	52-412	52-3893	52-3905	52-400	152-3893	152-3905
60"	52-413	52-3894	52-3906	52-401	152-3894	152-3906
72"	52-414	52-3895	52-3907	52-402	152-3895	152-3907
84"	52-415	52-3896	52-3908	52-403	152-3896	152-3908

Longer lengths are available custom order

Extensions can be purchased with or without the spray gun

Most extensions can ship in 2 weeks or less

Call for pricing



BINKS CONVENTIONAL SPRAY GUN EXTENSION STYLE "SC"

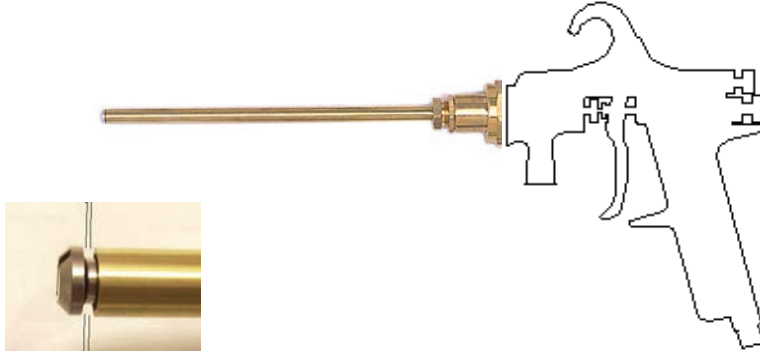

- * Used to coat the inside diameter of 3/4" to 12" pipe.
- * Needs to be pressure fed from a pressure tank, pump or pressure cup.
- * 360 degree spray pattern
- * Fits through a 3/8" clearance hole.
- * Best suited for thin to medium viscosity materials.
- * Long needle shuts material off at the tip.
- * Useable length of extension is approximately 1-1/2" shorter that extension length.

Extension Part Number chart for the following Binks Conventional Spray guns

Model → Length ↓	2100, 2001 or 2101	95	95A or 95AR	21
9"	52-1095	52-3849	52-4231	52-1107
12"	52-1096	52-3850	52-4232	52-1108
15"	52-1097	52-3851	52-4233	52-1109
18"	52-1098	52-3852	52-4234	52-1110
21"	52-1099	52-3853	52-4235	52-1111
27"	52-1100	52-3854	52-4236	52-1112
33"	52-1101	52-3855	52-4237	52-1113
39"	52-1102	52-3856	52-4238	52-1114
51"	52-1103	52-3857	52-4239	52-1115
63"	52-1104	52-3858	52-4240	52-1116
75"	52-1105	52-3859	52-4241	52-1117
87"	52-1106	52-3860	52-4242	52-1118

Longer lengths are available custom order
 Extensions can be purchased with or without the spray gun
 Most extensions can ship in 2 weeks or less
 Call for pricing





BINKS CONVENTIONAL SPRAY GUN EXTENSION STYLE "HC"



- * Used to coat the inside diameter of 2" to 24" pipe.
- * Needs to be pressure fed from a pressure tank, pump or pressure cup.
- * 360 degree spray pattern
- * Forward angle, forward angle/forward spray, right angle or reverse angle tip (specify when ordering).
- * Fits through a 3/4" clearance hole.
- * Best suited for medium to heavy viscosity materials.
- * Long needle shuts material off at the tip.
- * Useable length of extension is approximately 1-1/2" shorter than extension length.



52-365 Tip
Forward angle



52-363 Tip
Right angle



52-364 Tip
Reverse angle

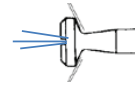

52-1621-1
Forward Angle
Forward Spray

Extension Part Number chart for the following Binks Conventional Spray guns

Model → Length ↓	2100, 2001 or 2101	95	95A or 95AR	21
6"	52-3549	52-3923	52-3937	52-3148
12"	52-3550	52-3924	52-3938	52-3183
18"	52-3551	52-3925	52-3939	52-3184
24"	52-3552	52-3926	52-3940	52-3185
30"	52-3553	52-3927	52-3941	52-3186
36"	52-3554	52-3928	52-3942	52-3187
42"	52-3555	52-3929	52-3943	52-3217
43-1/2"	52-3556	52-3930	52-3944	52-3188
48"	52-3557	52-3931	52-3945	52-3189
56"	52-3558	52-3932	52-3946	52-3218
60"	52-3559	52-3933	52-3947	52-3219
72"	52-3560	52-3934	52-3948	52-3220
80"	52-3561	52-3935	52-3949	52-3221
84"	52-3562	52-3936	52-3950	52-3222

Longer lengths are available custom order

Extensions can be purchased with or without the spray gun

Most extensions can ship in 2 weeks or less

Call for pricing



BINKS CONVENTIONAL SPRAY GUN EXTENSION STYLE "HCVT"



- * Used to coat the inside diameter of 3" to 24" pipe.
- * Needs to be pressure fed from a pressure tank, pump or pressure cup.
- * 360 degree spray pattern
- * Forward angle or right angle tip (specify when ordering).
- * Fits through a 1-1/8" clearance hole.
- * Best suited heavy viscosity materials.
- * Tungeston carbide nozzle assembly makes it suited for abrasive materials.
- * Long needle shuts material off at the tip.
- * Useable length of extension is approximately 1-1/2" shorter that extension length.

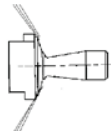

Forward angle

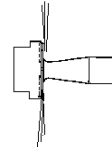

Right angle

Extension Part Number chart for the following Binks Conventional Spray guns

Model → Length ↓	2100, 2001 or 2101	95	95A or 95AR	21
6"	52-3535	52-3951	52-3965	52-3147
12"	52-3536	52-3952	52-3966	52-3169
18"	52-3537	52-3953	52-3967	52-3170
24"	52-3538	52-3954	52-3968	52-3171
30"	52-3539	52-3955	52-3969	52-3172
36"	52-3540	52-3956	52-3970	52-3173
42"	52-3541	52-3957	52-3971	52-3223
43.5"	52-3542	52-3958	52-3972	52-3174
48"	52-3543	52-3959	52-3973	52-3175
56"	52-3544	52-3960	52-3974	52-3224
60"	52-3545	52-3961	52-3975	52-3225
72"	52-3546	52-3962	52-3976	52-3226
80"	52-3547	52-3963	52-3977	52-3227
84"	52-3548	52-3964	52-3978	52-3228

Longer lengths are available custom order

Extensions can be purchased with or without the spray gun

Most extensions can ship in 2 weeks or less

Call for pricing





BINKS CONVENTIONAL SPRAY GUN EXTENSION STYLE "SCMBX"

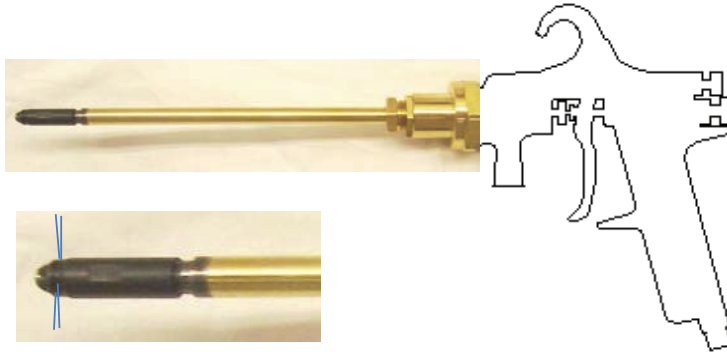

- * Fine atomization extension for spraying the inside of 3/4" to 12" pipe.
- * Needs to be pressure fed from a pressure tank, pump or pressure cup.
- * 360 degree spray pattern
- * Fits through a 3/8" clearance hole.
- * Best suited for thin to medium viscosity materials.
- * Long needle shuts material off at the tip.
- * Useable length of extension is approximately 1-1/2" shorter than extension length.

Extension Part Number chart for the following Binks Conventional Spray guns

Model → Length ↓	2100 , 2001 & 2101	95	95A or 95AR	21
9"	52-1095MBX	52-3849MBX	52-4231MBX	52-1107MBX
12"	52-1096MBX	52-3850MBX	52-4232MBX	52-1108MBX
15"	52-1097MBX	52-3851MBX	52-4233MBX	52-1109MBX
18"	52-1098MBX	52-3852MBX	52-4234MBX	52-1110MBX
21"	52-1099MBX	52-3853MBX	52-4235MBX	52-1111MBX
27"	52-1100MBX	52-3854MBX	52-4236MBX	52-1112MBX
33"	52-1101MBX	52-3855MBX	52-4237MBX	52-1113MBX
39"	52-1102MBX	52-3856MBX	52-4238MBX	52-1114MBX
51"	52-1103MBX	52-3857MBX	52-4239MBX	52-1115MBX
63"	52-1104MBX	52-3858MBX	52-4240MBX	52-1116MBX
75"	52-1105MBX	52-3859MBX	52-4241MBX	52-1117MBX
87"	52-1106MBX	52-3860MBX	52-4242MBX	52-1118MBX

Longer lengths are available custom order

Extensions can be purchased with or without the spray gun

Most extensions can ship in 2 weeks or less

Call for pricing

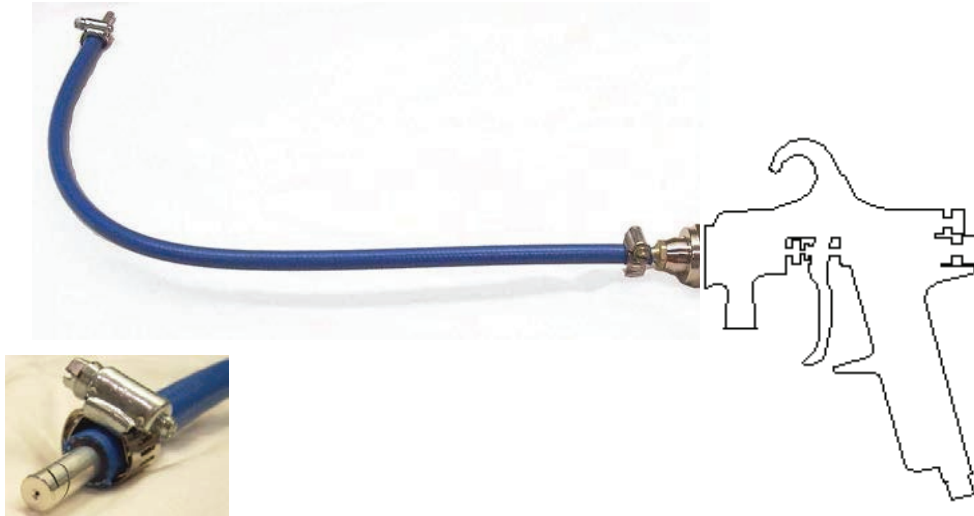

BINKS CONVENTIONAL SPRAY GUN EXTENSION 52-2410

- * Typically used to coat the inside diameter of curved pipes or other hard to reach areas
- * Needs to be pressure fed from a pressure tank, pump or pressure cup.
- * 5/16" ID fluid hose 71-508 (or equal) and hose clamps (by customer)
- * Hose length as required by application (by customer)
- * 360 degree spray pattern
- * Fits through an approximately 1" clearance hole.
- * Best suited for thin to medium viscosity materials.
- * Will attach to any of the following Binks Spray guns: 2101, 2100, 2001, 95, 95SL, 95A, 95AR or 21

Extensions can be purchased with or without the spray gun

Most extensions can ship in 2 weeks or less

Call for pricing

BINKS CONVENTIONAL SPRAY GUN EXTENSION 52-1382

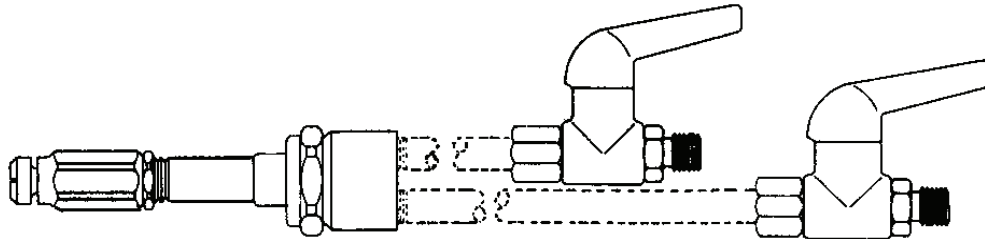

52-363 Tip
Right angle

- * Typically used to coat the inside diameter of 4" to 24" pipe.
 - * Needs to be pressure fed from a pressure tank, pump or pressure cup.
 - * 360 degree spray pattern
 - * Fits through a 1-3/4" clearance hole.
 - * Best suited for thin to medium viscosity materials.
 - * Requires 2 ea 1/4" npt pipes from ball valves to extension body (by customer)
 - * Used when spraying I.D. of excessively long pipes
 - * Air and material shut off with ball valves
 - * For Heavier viscosities order 52-3511 - uses "HC" style extension
- * 52-1382 Extension consists of:
- 52-883 Manifold Body
 - 52-1381 6" "C" Extension
 - 72-81414 Ball Valves
 - 57-13 Nipple
 - 83-4233 Nipple
 - 54-918 Gasket
 - 2 pcs 1/4" Diameter Pipe by Customer

Most extensions can ship in 2 weeks or less
Call for pricing



BINKS CONVENTIONAL SPRAY GUN EXTENSION STYLE "EA"

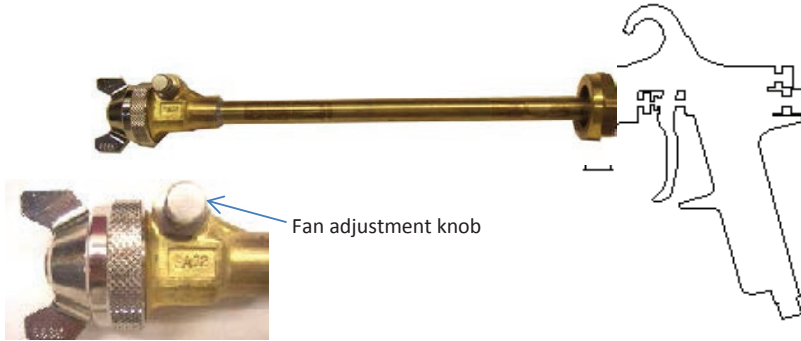

- * Extended reach forward Spray Pattern
- * Needs to be pressure fed from a pressure tank, pump or pressure cup.
- * Uses any of the standard "60" series fluid nozzle and air cap (specify when ordering).
- * Fits through a 1-3/4" clearance diameter.
- * Adjustment knob for fan control.
- * The head of the extension is fixed, it does not swivel for angular spray.
- * Long needle shuts material off at the tip.
- * Useable length of extension is approximately 1-1/2" shorter that extension length.

Extension Part Number chart for the following Binks Conventional Spray guns

Model → Length ↓	2100, 2001 or 2101	95	95A or 95AR	21	Trophy Hand	Trophy Auto
6"	52-670	52-4051	52-4063	52-706	152-4051	152-4063
9"	52-671	52-4052	52-4064	52-707	152-4052	152-4064
12"	52-672	52-4053	52-4065	52-708	152-4053	152-4065
15"	52-673	52-4054	52-4066	52-709	152-4054	152-4066
18"	52-674	52-4055	52-4067	52-710	152-4055	152-4067
24"	52-675	52-4056	52-4068	52-711	152-4056	152-4068
30"	52-676	52-4057	52-4069	52-712	152-4057	152-4069
36"	52-677	52-4058	52-4070	52-713	152-4058	152-4070
48"	52-678	52-4059	52-4071	52-714	152-4059	152-4071
60"	52-679	52-4060	52-4072	52-715	152-4060	152-4072
72"	52-680	52-4061	52-4073	52-716	152-4061	152-4073
84"	52-681	52-4062	52-4074	52-717	152-4062	152-4074

Longer lengths are available custom order
 Extensions can be purchased with or without the spray gun
 Most extensions can ship in 2 weeks or less
 Call for pricing





BINKS CONVENTIONAL SPRAY GUN EXTENSION STYLE "EAX"



- * Extended reach forward Spray Pattern
- * Needs to be pressure fed from a pressure tank, pump or pressure cup.
- * Choice of fluid nozzle and air cap (see below)(specify when ordering)
- * Fits through a 7/8" clearance diameter.
- * The head of the extension is a fixed forward spray, it does not swivel.
- * Needle shuts material off at the tip.
- * Useable length of extension is approximately 1-1/2" shorter than extension length.
- * Available Fluid Nozzles and Air Caps:
 - 45-1022 J2 Fluid Nozzle .043" orifice
 - 45-1023 J3 Fluid Nozzle .035" orifice
 - 46-1031 AA1 External Mix Fan Spray
 - 46-1042 R-6SS External Mix Round Spray

Model → Length ↓	2100, 2001 or 2101	95	95A or 95AR	21
6"	52-249	52-4135	52-4147	52-285
9"	52-250	52-4136	52-4148	52-286
12"	52-251	52-4137	52-4149	52-287
15"	52-252	52-4138	52-4150	52-288
18"	52-253	52-4139	52-4151	52-289
24"	52-254	52-4140	52-4152	52-290
30"	52-255	52-4141	52-4153	52-291
36"	52-256	52-4142	52-4154	52-292
48"	52-257	52-4143	52-4155	52-293
60"	52-258	52-4144	52-4156	52-294
72"	52-259	52-4145	52-4157	52-295
84"	52-260	52-4146	52-4158	52-296

Longer lengths are available custom order
 Extensions can be purchased with or without the spray gun
 Most extensions can ship in 2 weeks or less
 Call for pricing



BINKS CONVENTIONAL SPRAY GUN EXTENSION STYLE "SA"

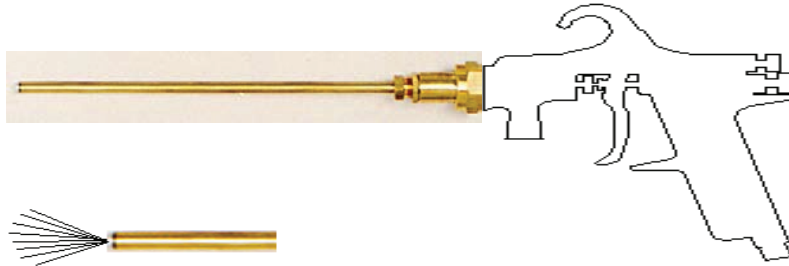

- * Extended reach forward Spray Pattern
- * Needs to be pressure fed from a pressure tank, pump or pressure cup.
- * Forward spray pattern
- * Fits through a 7/16" clearance hole.
- * Best suited for thin to medium viscosity materials.
- * Long needle shuts material off at the tip.
- * Useable length of extension is approximately 1-1/2" shorter than extension length.

Extension Part Number chart for the following Binks Conventional Spray guns

Model → Length ↓	2100, 2001 or 2101	95	95A or 95AR	21
6"	52-1009	52-4015	52-4027	52-1021
9"	52-1010	52-4016	52-4028	52-1022
12"	52-1011	52-4017	52-4029	52-1023
15"	52-1012	52-4018	52-4030	52-1024
18"	52-1013	52-4019	52-4031	52-1025
24"	52-1014	52-4020	52-4032	52-1026
30"	52-1015	52-4021	52-4033	52-1027
36"	52-1016	52-4022	52-4034	52-1028
48"	52-1017	52-4023	52-4035	52-1029
60"	52-1018	52-4024	52-4036	52-1030
72"	52-1019	52-4025	52-4037	52-1031
84"	52-1020	52-4026	52-4038	52-1032

Longer lengths are available custom order

Extensions can be purchased with or without the spray gun

Most extensions can ship in 2 weeks or less

Call for pricing





BINKS CONVENTIONAL SPRAY GUN EXTENSION STYLE "EN"

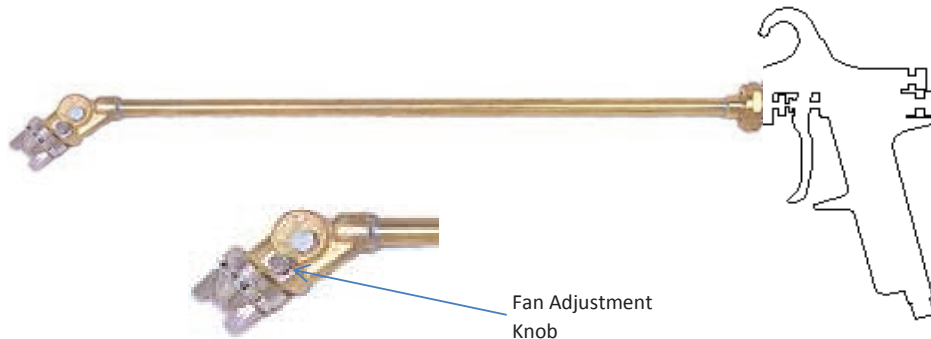

- * Extended reach, Spray Pattern on 45 degree angle.
- * Needs to be pressure fed from a pressure tank, pump or pressure cup.
- * Uses any of the standard "60" series fluid nozzle and air cap (specify when ordering).
- * Fits through a 2-1/2" clearance diameter.
- * Adjustment knob for fan control.
- * The head of the extension is a fixed 45 degree spray, it does not swivel.
- * Needle shuts material off at the tip.
- * Useable length of extension is approximately 1-1/2" shorter that extension length.

Extension Part Number chart for the following Binks Conventional Spray guns

Model → Length ↓	2100 , 2001 or 2101	95	95A or 95AR	21	Trophy Hand	Trophy Auto
6"	52-694	52-4099	52-4111	52-730	152-4099	152-4111
9"	52-695	52-4100	52-4112	52-731	152-4100	152-4112
12"	52-696	52-4101	52-4113	52-732	152-4101	152-4113
15"	52-697	52-4102	52-4114	52-733	152-4102	152-4114
18"	52-698	52-4103	52-4115	52-734	152-4103	152-4115
24"	52-699	52-4104	52-4116	52-735	152-4104	152-4116
30"	52-700	52-4105	52-4117	52-736	152-4105	152-4117
36"	52-701	52-4106	52-4118	52-737	152-4106	152-4118
48"	52-702	52-4107	52-4119	52-738	152-4107	152-4119
60"	52-703	52-4108	52-4120	52-739	152-4108	152-4120
72"	52-704	52-4109	52-4121	52-740	152-4109	152-4121
84"	52-705	52-4110	52-4122	52-741	152-4110	152-4122

Longer lengths are available custom order
 Extensions can be purchased with or without the spray gun
 Most extensions can ship in 2 weeks or less
 Call for pricing



BINKS CONVENTIONAL SPRAY GUN EXTENSION STYLE "ENX"



- * Extended reach, Spray Pattern on 45 degree angle.
- * Needs to be pressure fed from a pressure tank, pump or pressure cup.
- * Fits through a 1-3/4" clearance diameter.
- * Adjustment knob for fan control.
- * The head of the extension is a fixed 45 degree spray, it does not swivel.
- * Needle shuts material off at the tip.
- * Useable length of extension is approximately 1-1/2" shorter that extension length.
- * Available Fluid Nozzles and Air Caps:
 - 45-1022 J2 Fluid Nozzle .043" orifice
 - 45-1023 J3 Fluid Nozzle .035" orifice
 - 46-1031 AA1 External Mix Fan Spray
 - 46-1042 R-6SS External Mix Round Spray

Extension Part Number chart for the following Binks Conventional Spray guns

Model → Length ↓	2100, 2001 or 2101	95	95A or 95AR	21
6"	52-261	52-4183	52-4195	52-297
9"	52-262	52-4184	52-4196	52-298
12"	52-263	52-4185	52-4197	52-299
15"	52-264	52-4186	52-4198	52-300
18"	52-265	52-4187	52-4199	52-301
24"	52-266	52-4188	52-4200	52-302
30"	52-267	52-4189	52-4201	52-303
36"	52-268	52-4190	52-4202	52-304
48"	52-269	52-4191	52-4203	52-305
60"	52-270	52-4192	52-4204	52-306
72"	52-271	52-4193	52-4205	52-307
84"	52-272	52-4194	52-4206	52-308

Longer lengths are available custom order
 Extensions can be purchased with or without the spray gun
 Most extensions can ship in 2 weeks or less
 Call for pricing





BINKS CONVENTIONAL SPRAY GUN EXTENSION STYLE "ERX"



- * Extended reach, Spray Pattern on 45 degree reverse angle.
- * Needs to be pressure fed from a pressure tank, pump or pressure cup.
- * Fits through a 1-3/4" clearance diameter.
- * Adjustment knob for fan control.
- * The head of the extension is a fixed 45 degree reverse spray, it does not swivel.
- * Needle shuts material off at the tip.
- * Useable length of extension is approximately 1-1/2" shorter than extension length.
- * Available Fluid Nozzles and Air Caps:
 - 45-1022 J2 Fluid Nozzle .043" orifice
 - 45-1023 J3 Fluid Nozzle .035" orifice
 - 46-1031 AA1 External Mix Fan Spray
 - 46-1042 R-6SS External Mix Round Spray

Extension Part Number chart for the following Binks Conventional Spray guns

Model → Length ↓	2100, 2001 or 2101	95	95A or 95AR	21
6"	52-453	52-4207	52-4219	52-465
9"	52-454	52-4208	52-4220	52-466
12"	52-455	52-4209	52-4221	52-467
15"	52-456	52-4210	52-4222	52-468
18"	52-457	52-4211	52-4223	52-469
24"	52-458	52-4212	52-4224	52-470
30"	52-459	52-4213	52-4225	52-471
36"	52-460	52-4214	52-4226	52-472
48"	52-461	52-4215	52-4227	52-473
60"	52-462	52-4216	52-4228	52-474
72"	52-463	52-4217	52-4229	52-475
84"	52-464	52-4218	52-4230	52-476

Longer lengths are available custom order
 Extensions can be purchased with or without the spray gun
 Most extensions can ship in 2 weeks or less
 Call for pricing



BINKS CONVENTIONAL SPRAY GUN EXTENSION STYLE "EB"

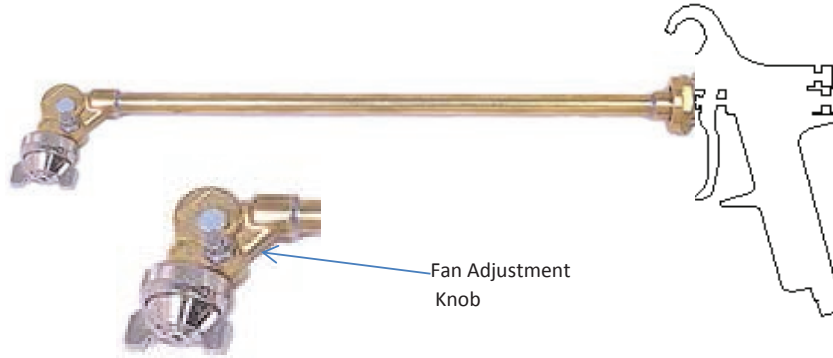

- * Extended reach, Spray Pattern on 90 degree angle.
- * Needs to be pressure fed from a pressure tank, pump or pressure cup.
- * Uses any of the standard "60" series fluid nozzle and air cap (specify when ordering).
- * Fits through a 3" clearance diameter.
- * Adjustment knob for fan control.
- * The head of the extension is a fixed 90 degree spray, it does not swivel.
- * Needle shuts material off at the tip.
- * Useable length of extension is approximately 1-1/2" shorter that extension length.

Extension Part Number chart for the following Binks Conventional Spray guns

Model → Length ↓	2100, 2001 or 2101	95	95A or 95AR	21	Trophy Hand Trophy Auto	
6"	52-682	52-4075	52-4087	52-718	152-4075	152-4087
9"	52-683	52-4076	52-4088	52-719	152-4076	152-4088
12"	52-684	52-4077	52-4089	52-720	152-4077	152-4089
15"	52-685	52-4078	52-4090	52-721	152-4078	152-4090
18"	52-686	52-4079	52-4091	52-722	152-4079	152-4091
24"	52-687	52-4080	52-4092	52-723	152-4080	152-4092
30"	52-688	52-4081	52-4093	52-724	152-4081	152-4093
36"	52-689	52-4082	52-4094	52-725	152-4082	152-4094
48"	52-690	52-4083	52-4095	52-726	152-4083	152-4095
60"	52-691	52-4084	52-4096	52-727	152-4084	152-4096
72"	52-692	52-4085	52-4097	52-728	152-4085	152-4097
84"	52-693	52-4086	52-4098	52-729	152-4086	152-4098

Longer lengths are available custom order

Extensions can be purchased with or without the spray gun

Most extensions can ship in 2 weeks or less

Call for pricing



BINKS CONVENTIONAL SPRAY GUN EXTENSION STYLE "EBX"



- * Extended reach, Spray Pattern on 90 degree angle.
- * Needs to be pressure fed from a pressure tank, pump or pressure cup.
- * Choice of fluid nozzle and air cap (see below)(specify when ordering)
- * Fits through a 1-7/8" clearance diameter.
- * The head of the extension is a fixed 90 degree spray, it does not swivel.
- * Needle shuts material off at the tip.
- * Useable length of extension is approximately 1-1/2" shorter than extension length.
- * Available Fluid Nozzles and Air Caps:
 - 45-1022 J2 Fluid Nozzle .043" orifice
 - 45-1023 J3 Fluid Nozzle .035" orifice
 - 46-1031 AA1 External Mix Fan Spray
 - 46-1042 R-6SS External Mix Round Spray

Extension Part Number chart for the following Binks Conventional Spray guns

Model → Length ↓	2100, 2001 or 2101	95	95A or 95AR	21
6"	52-273	52-4159	52-4171	5-309
9"	52-274	52-4160	52-4172	5-310
12"	52-275	52-4161	52-4173	5-311
15"	52-276	52-4162	52-4174	5-312
18"	52-277	52-4163	52-4175	5-313
24"	52-278	52-4164	52-4176	5-314
30"	52-279	52-4165	52-4177	5-315
36"	52-280	52-4166	52-4178	5-316
48"	52-281	52-4167	52-4179	5-317
60"	52-282	52-4168	52-4180	5-318
72"	52-283	52-4169	52-4181	5-319
84"	52-284	52-4170	52-4182	5-320

Longer lengths are available custom order
 Extensions can be purchased with or without the spray gun
 Most extensions can ship in 2 weeks or less
 Call for pricing





BINKS SPRAY GUN EXTENSIONS

BINKS MACH SERIES HVLP SPRAY GUN EXTENSIONS

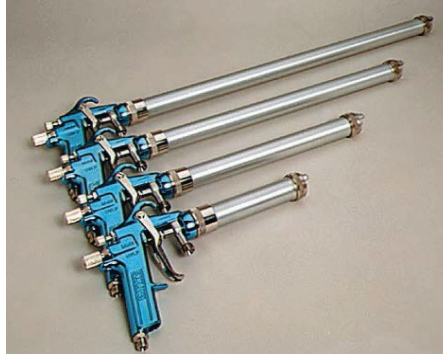

- * Used to spray high, low or hard to reach surfaces.
- * Needs to be pressure fed from a pressure tank, pump or pressure cup.
- * Uses any of the standard "90" series HVLP fluid nozzles and air caps.
- * Fluid nozzle and air cap are not furnished with this extension.
- * Fits through a 1-3/4" clearance diameter.
- * The head of the extension is fixed, it does not swivel for angular spray.
- * Long needle shuts material off at the tip.
- * Fits the Mach 1, Mach 1SL, Mach 1A, Mach 1AR and MAG HVLP Spray guns.
- * Angle Heads available for angular spray (order separately).

Length	Part Number	Length	Part Number
6"	52-3706	24"	52-3724
12"	52-3712	36"	52-3736
18"	52-3718	42"	52-3742

Longer lengths are available custom order
 Most extensions can ship in 2 weeks or less
 Call for pricing



54-5600 EXTENSION FOR MACH1 AND MACH 1SL SPRAY GUNS



54-5612 NOZZLE TIP



54-5614 NOZZLE TIP



54-5616 NOZZLE TIP

- * Used to spray hard to reach surfaces.
- * Needs to be pressure fed from a pressure tank, pump or pressure cup.
- * Compatible with any of the standard "90" series HVLP fluid nozzles.
- * Extension comes complete with the three nozzle tips shown above.
- * Fits through a 3/8" clearance hole.
- * Slot in each tip is 1/32" wide
- * Waterborne compatible. (Anodized Aluminum tube, Stainless steel tips)
- * Material is shut off at front of gun, no long needle.
- * Standard 54-5600 extension is 8-1/2" useable length

Longer lengths are available custom order
Most extensions can ship in 2 weeks or less
Call for pricing





EXTENSIONS FOR AIRLESS 1 SPRAY GUN



- * Used to extend your reach.
- * Fluid is shut of at the front of the gun.
- * Extensions do not include gun

LENGTH	PART NUMBER
6"	52-2901
9"	52-2902
12"	52-2903
15"	52-2904
18"	52-2905
24"	52-2906
30"	52-2907
36"	52-2908
48"	52-2909

Longer lengths are available custom order
Most extensions can ship in 2 weeks or less
Call for pricing



Airless 75 Gun Extensions



- * Used to extend your reach.
- * Fluid is shut off at the front of the gun.
- * Fits Airless 75 Spray Guns
- * Use 49-1834 adapter to use on Airless 1 Spray guns
- * Use 52-5207 Airless Swivel Head for angular spray
- * Extension does not include airless tip or tip guard

52-5208	36"	7500 PSI	Airless Tip Extension
52-5209	60"	7500 PSI	Airless Tip Extension

Most extensions can ship in 2 weeks or less



52-5207 Airless Swivel Head





BINKS SPRAY GUN EXTENSIONS

BINKS CONVENTIONAL RUSTPROOFING EXTENSIONS



52-3407 Rigid 26" Extension with 180 degree spray pattern
52-3406 Rigid 60" Extension with 180 degree spray pattern



52-3408 Flexible Extension with 360 degree spray pattern

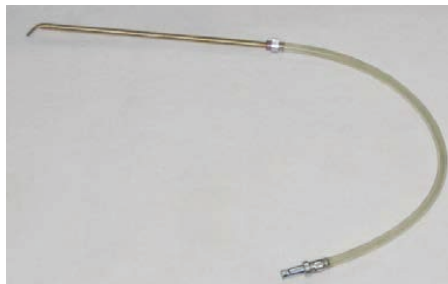

52-3411 Superflex Extension with Flat Spray pattern



52-3405 Rigid Extension with Flat Spray pattern

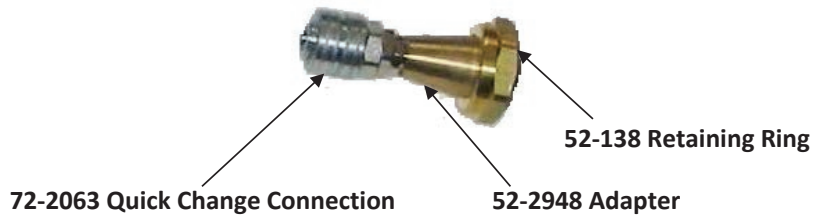

- * For Spraying Rustproofing Materials in difficult areas
- * Use with 2101, 2100, 95, 95SL or 2001 Spray Gun (Purchase Separately)
- * Needs to be pressure fed from a pressure tank or pump
- * 52-2948 Adapter, 52-138 Retaining Ring and 72-2064 QC Connector required to connect to Spray Gun
- * For thin rustproofing materials only
- * 67SS Fluid Nozzle Required in Spray Gun
- * Most extensions can ship in 2 weeks or less
- * Call for pricing

RUST PROOFING EXTENSIONS

- 54-3405 RIGID EXTENSION
- 54-3406 RIGID EXTENSION
- 54-3407 RIGID EXTENSION
- 54-3408 FLEXIBLE EXTENSION
- 52-3411 SUPERFLEX EXTENSION
- 52-138 RETAINING RING
- 52-2948 ADAPTER
- 52-RUST Rust Proofing Package less gun



54-928 CLEANING NOZZLE ATTACHMENT

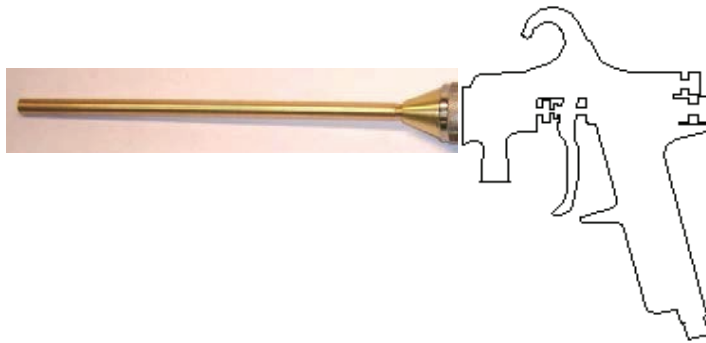

- * Works as Pressure Feed or Siphon Feed
- * Remove standard air cap on gun and attach Cleaning Attachment
- * 10" Long, 1/4" diameter
- * Works on 2101, 2100, 95, 95SL and 2001 Spray guns
- * Material shut off is at front of gun
- * Forward Spray only
- * Designed to spray solvent or water for cleaning parts



BINKS SPRAY GUN EXTENSION ARM



- * Allows Painter to Spray Hard to reach Places
- * Extension Arm fits Spray Gun Models
- * Must be Pressure Fed from Pressure Tank or Pump
- * Available in 4', 6' and 8' lengths
- * 73-131 Adapter required for some Spray Guns (order separately). See Chart Below

Length	Extension Number
4'	54-296
6'	54-297
8'	54-298

Spray Gun compatibility chart

Binks 2101 Spray gun	73-131 adapter not required
Binks 2100 Spray Gun	73-131 adapter not required
Binks Model 7 Spray Gun	73-131 adapter not required
Binks 2001 Spray Gun	73-131 adapter not required
Binks Mach 1 HVLP Spray Gun	Requires 1 ea 73-131 adapter
Binks Mach 1SL HVLP Spray Gun	Requires 1 ea 73-131 adapter
Binks 95 Spray Gun	Requires 1 ea 73-131 adapter
Binks 95SL Spray Gun	Requires 1 ea 73-131 adapter
Binks SV100 Spray Gun	Requires 1 ea 73-131 adapter
DeVilbiss MBC Spray Gun	
DeVilbiss JGA Spray Gun	73-131 adapter not required
DeVilbiss JGHV HVLP Spray Gun	Requires 1 ea 73-131 adapter
DeVilbiss EXL Spray Gun	Requires 1 ea 73-131 adapter
DeVilbiss FLG-III Spray Gun	Requires 1 ea 73-131 adapter
DeVilbiss Compact Series	Requires 1 ea 73-131 adapter
DeVilbiss Compact Series	Requires 2 ea 73-131 adapter





Part Sheet and Service Bulletin reference:

Extension Style ↓	2101, 2100 & 2001 Spray gun	95 Spray Gun	95A and 95AR Spray Gun	21 Spray Gun
"C"	77-1367	77-2659	77-2660	77-1367
"SC"	77-1328	77-2659	77-2660	77-1328
"HC"	77-2082	77-2659	77-2660	77-2082
"HCVT"	77-2083	77-2659	77-2660	77-2083
"SCMBX"	77-5586	77-5586	77-5586	77-5586
"EA"	77-1368	77-2659	77-2660	77-1368
"EAX"	77-1369	77-2659	77-2660	77-1369
"SA"	77-1328	77-2659	77-2660	77-1328
"EN:	77-1372	77-2659	77-2660	77-1372
"ENX"	77-1373	77-2659	77-2660	77-1373
"ERX"	77-1374	77-2659	77-2660	77-1374
"EB"	77-1370	77-2659	77-2660	77-1370
"EBX"	77-1371	77-2659	77-2660	77-1371
52-2410	A52-3R-14	A52-3R-14	A52-3R-14	A52-3R-14
52-1382	No Gun Circular 360	A52-3R-14 & 77-1367		
	Mach Series HVLP Extensions	77-2557		
54-5600	Mach series (Interior surface)	77-2834		
52-296	Extension Arm	77-1120		
	Rust Proofer Extensions	None		
54-928	Cleaning Extension	None		
	Airless 1 Gun Extensions	None		
	Airless 75 Extensions	None		



***Sales and Service through our
Global Network of Industrial Distributors***

Binks International Offices

Americas: **USA** ▪ **Mexico** ▪ **Brazil**

Europe/Asia/Africa: **United Kingdom** ▪ **France** ▪ **Germany**

Pacific Rim: **China** ▪ **Japan** ▪ **Australia**

BINKS[®]

www.binks.com

1.800.99.BINKS

www.finishingbrands.com

