

BINKS MODEL 95 SPRAY GUN 6121-XXXX-X



Model 95 Signature Series Spray Gun

This handheld gun is the premier spray gun in the Binks line. A combination of the three best industrial spray guns, Model 95 sets a new standard.

The Model 95 is a high production gun with stainless steel fluid passages which may be used with most coatings. This new gun replaces Models 18, 62 and BBR spray guns, incorporating the best features of all three: drop-forged anodized aluminum body, stainless steel fluid passages, adjustable floating needle valve, stainless steel or tungsten carbide fluid nozzle, plated drop-forged brass self-centering air nozzle, brass air valve cartridge, adjustable spray pattern, 3/8" NPS(m) fluid inlet, 1/4" NPS(m) air inlet. Weight 1 lb., 11 oz.



Illustration Key

1. Air Nozzle Assembly
2. Gun Body
3. Side Port Controls
4. Fluid Control Knob
5. Air Connection 1/4" NPS(m)
6. Fluid Connection 3/8" NPS(m)

TYPES OF INSTALLATION

SIPHON FEED CUP HOOKUP

Air pressure for atomization is regulated at extractor. The amount of fluid is adjusted by fluid control screw on gun, viscosity of paint, and air pressure (see figure 1).

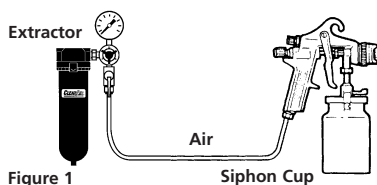

Figure 1

PRESSURE FEED CUP HOOKUP

For fine finishing with limited spraying.

Air pressure for atomization is regulated at extractor; fluid pressure at cup regulator. For heavy fluids and internal mix nozzle spraying, fluid adjusted by control screw on gun.

Pressure cup also available less regulator (see figure 2).

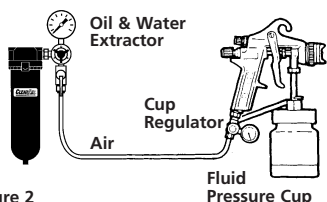

Figure 2

PRESSURE FEED TANK HOOKUP

For medium production spraying (single regulator).

Air pressure for atomization is regulated at extractor, fluid pressure at tank regulator (see figure 3).

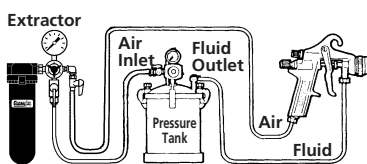

Figure 3

PRESSURE FEED TANK HOOKUP

For portable painting operations (double regulator).

Air pressure for atomization and fluid supply is regulated by two individual air regulators on tank (see figure 4).

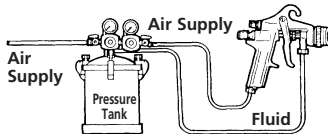

Figure 4

PRESSURE FEED CIRCULATING HOOKUP

For heavy production spraying.

Air pressure atomization regulated at extractor. Fluid pressure regulated at fluid regulator (see figure 5).

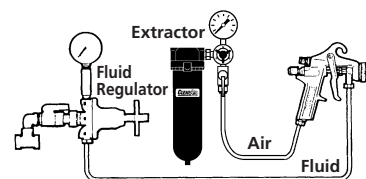

Figure 5

In this part sheet, the words **WARNING**, **CAUTION** and **NOTE** are used to emphasize important safety information as follows:

WARNING

Hazards or unsafe practices which could result in severe personal injury, death or substantial property damage.

CAUTION

Hazards or unsafe practices which could result in minor personal injury, product or property damage.

NOTE

Important installation, operation or maintenance information.

WARNING

Read the following warnings before using this equipment.



READ THE MANUAL

Before operating finishing equipment, read and understand all safety, operation and maintenance information provided in the operation manual.



OPERATOR TRAINING

All personnel must be trained before operating finishing equipment.



EQUIPMENT MISUSE HAZARD

Equipment misuse can cause the equipment to rupture, malfunction, or start unexpectedly and result in serious injury.



LOCK OUT / TAG-OUT

Failure to de-energize, disconnect, lock out and tag-out all power sources before performing equipment maintenance could cause serious injury or death.



AUTOMATIC EQUIPMENT

Automatic equipment may start suddenly without warning.



PRESSURE RELIEF PROCEDURE

Always follow the pressure relief procedure in the equipment instruction manual.



KEEP EQUIPMENT GUARDS IN PLACE

Do not operate the equipment if the safety devices have been removed.



KNOW WHERE AND HOW TO SHUT OFF THE EQUIPMENT IN CASE OF AN EMERGENCY



WEAR SAFETY GLASSES

Failure to wear safety glasses with side shields could result in serious eye injury or blindness.



INSPECT THE EQUIPMENT DAILY

Inspect the equipment for worn or broken parts on a daily basis. Do not operate the equipment if you are uncertain about its condition.



NEVER MODIFY THE EQUIPMENT

Do not modify the equipment unless the manufacturer provides written approval.



NOISE HAZARD

You may be injured by loud noise. Hearing protection may be required when using this equipment.

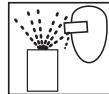

PROJECTILE HAZARD

You may be injured by venting liquids or gases that are released under pressure, or flying debris.



PINCH POINT HAZARD

Moving parts can crush and cut. Pinch points are basically any areas where there are moving parts.



STATIC CHARGE

Fluid may develop a static charge that must be dissipated through proper grounding of the equipment, objects to be sprayed and all other electrically conductive objects in the dispensing area. Improper grounding or sparks can cause a hazardous condition and result in fire, explosion or electric shock and other serious injury.



WEAR RESPIRATOR

Toxic fumes can cause serious injury or death if inhaled. Wear a respirator as recommended by the fluid and solvent manufacturer's Safety Data Sheet.



TOXIC FLUID & FUMES

Hazardous fluid or toxic fumes can cause serious injury or death if splashed in the eyes or on the skin, inhaled, injected or swallowed. LEARN and KNOW the specific hazards of the fluids you are using.



FIRE AND EXPLOSION HAZARD

Improper equipment grounding, poor ventilation, open flame or sparks can cause a hazardous condition and result in fire or explosion and serious injury.



MEDICAL ALERT

Any injury caused by high pressure liquid can be serious. If you are injured or even suspect an injury:

- Go to an emergency room immediately.
- Tell the doctor you suspect an injection injury.
- Show the doctor this medical information or the medical alert card provided with your airless spray equipment.
- Tell the doctor what kind of fluid you were spraying or dispensing.



GET IMMEDIATE MEDICAL ATTENTION

To prevent contact with the fluid, please note the following:

- Never point the gun/valve at anyone or any part of the body.
- Never put hand or fingers over the spray tip.
- Never attempt to stop or deflect fluid leaks with your hand, body, glove or rag.
- Always have the tip guard on the spray gun before spraying.
- Always ensure that the gun trigger safety operates before spraying.



CA PROP
65

PROP 65 WARNING

WARNING: This product contains chemicals known to the State of California to cause cancer and birth defects or other reproductive harm.

IT IS THE RESPONSIBILITY OF THE EMPLOYER TO PROVIDE THIS INFORMATION TO THE OPERATOR OF THE EQUIPMENT. FOR FURTHER SAFETY INFORMATION REGARDING THIS EQUIPMENT, SEE THE GENERAL EQUIPMENT SAFETY BOOKLET (77-5300).

Binks reserves the right to modify equipment specification without prior notice.

AIR PRESSURE

Atomizing pressure must be set properly to allow for the drop in air pressure between the regulator and the spray gun.

With 60 psi applied at air supply



Cross section view showing comparison of inside hose diameters (actual size). 60 lbs. regulated pressure

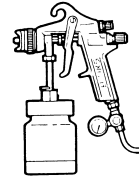

Only 34 PSI at gun inlet
25 feet of 1/4" I.D. hose causes a drop of 26 PSI between the air supply and the gun.
(NOT RECOMMENDED)



48 PSI at gun inlet
25 feet of 5/16" I.D. hose causes a drop of 12 PSI between the air supply and the gun. For this reason Binks recommends the use of 5/16" hose.
(RECOMMENDED)

BINKS OIL AND WATER EXTRACTOR IS IMPORTANT

Achieving a fine spray finish without the use of a good oil and water extractor is virtually impossible.

A Binks regulator / extractor serves a double purpose. It eliminates blistering and spotting by keeping air free of oil and water, and it gives precise air pressure control at the gun.

Binks recommends using Model HFRL-508 Oil and Water Extractor / Regulator. See your local distributor for other models.

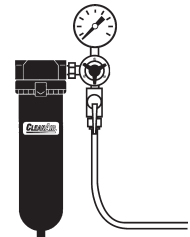

GUN HANDLING

The first requirement for a good resultant finish is the proper handling of the gun. The gun should be held perpendicular to the surface being covered and moved parallel with it. The stroke should be started before the trigger is pulled and the trigger should be released before the stroke is ended. This gives accurate control of the gun and material.

The distance between gun and surface should be 6 to 12 inches depending on material and atomizing pressure. The material deposited should always be even and wet. Lap each stroke over the preceding stroke to obtain a uniform finish.

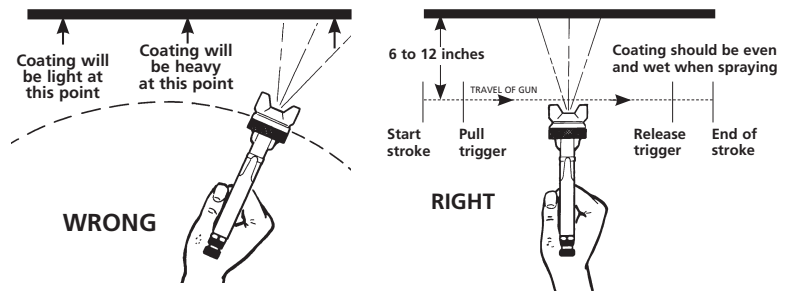

NOTE

To reduce overspray and obtain maximum efficiency, always spray with the lowest possible atomizing air pressure.

AIR SUPPLY

It is extremely poor practice to mount the oil and water extractor on or even near the compressor unit. The temperature of the air is greatly increased as it passes through the compressor and this compressed air must be cooled before the moisture in it will condense. If the air from the compressor is still warm when it passes through the oil and water extractor, moisture will not be effectively removed, but will remain in suspension. Then, when the air cools in the hose beyond the extractor, the moisture will condense into drops of water and cause trouble.

Air lines must be properly drained

Pitch all air lines back towards the compressor so that condensed moisture will flow back into the air receiver where it can be removed by opening a drain. Every low point on an air line acts as a water trap. Such points should be fitted with an easily accessible drain. See diagram.

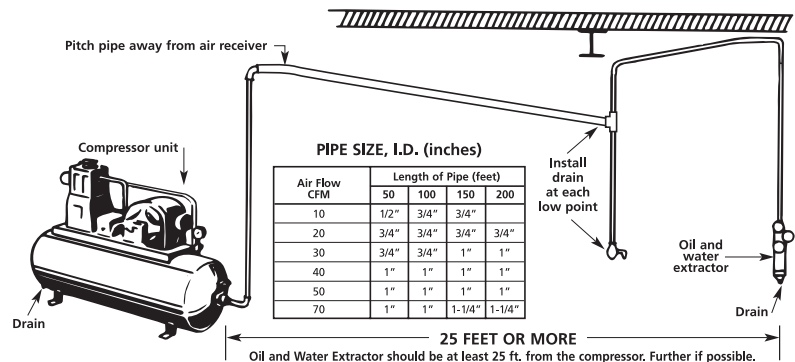

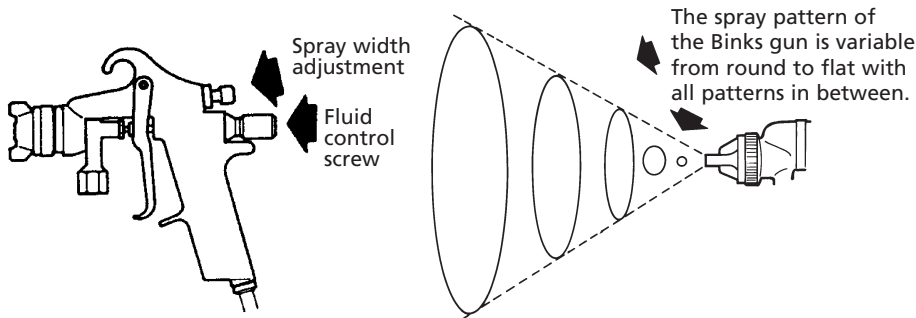

In normal operation, the wings on the nozzle are horizontal as illustrated here. This provides a vertical fan shaped pattern which gives maximum coverage as the gun is moved back and forth parallel to the surface being finished.

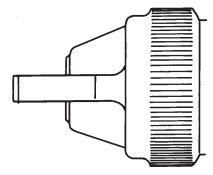

Spray width adjustment: Turn clockwise for round, counterclockwise for fan.

Fluid control screw: Turn clockwise to decrease flow, counterclockwise to increase flow.

As width of spray is increased, more material must be allowed to pass through the gun to obtain the same coverage on the increased area.





SIPHON SPRAYING

Set atomization pressure at approximately 50 PSI for lacquer and 60 PSI for enamel. Test spray. If the spray is too fine, reduce the air pressure or open fluid control screw. If the spray is too coarse, close the fluid control screw. Adjust the pattern width and repeat adjustment of spray if necessary.

PRESSURE SPRAYING

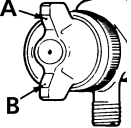
After selecting correct size fluid orifice, set fluid pressure for desired flow. Open atomization air and test spray. If spray is too fine, reduce air pressure. If spray is too coarse, raise air pressure. Adjust pattern width and repeat adjustment of spray. Keeping fluid control screw in open position will reduce fluid needle wear.

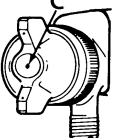
FAULTY PATTERNS AND HOW TO CORRECT THEM

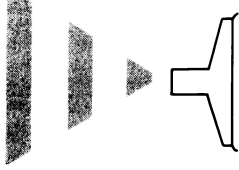
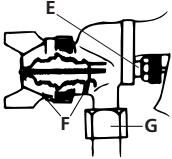
PATTERN	CAUSE	CORRECTION
	Dried material in side-port "A" restricts passage of air. Greater flow of air from cleaner side-port "B" forces fan pattern in direction of clogged side. 	Dissolve material in side-ports with thinner, then blow gun clean. Do not poke into openings with metal instruments.
	Dried material around the outside of the fluid nozzle tip at position "C" restricts the passage of atomizing air at one point through the center opening of air nozzle and results in pattern shown. This pattern can also be caused by a loose air nozzle. 	Remove air nozzle and wipe off fluid tip using rag wet with thinner. Tighten air nozzle.
	A split spray or one that is heavy on each end of a fan pattern and weak in the middle is usually caused by: (1) Too high an atomization air pressure (2) Attempting to get too wide a spray pattern with thin material.	Reducing air pressure will correct cause (1). To correct cause (2), open material control to full position by turning to left. At the same time, turn spray width adjustment to right. This will reduce width of spray, but will correct split spray pattern.
	(1) Dried out packing around material needle valve permits air to get into fluid passageway. This results in spitting. (2) Dirt between fluid nozzle seat and body or loosely installed fluid nozzle will make gun spit. (3) A loose or defective swivel nut on siphon cup or material hose can cause spitting.	 To correct cause (1) back up knurled nut (E), place two drops of machine oil on packing, replace nut and tighten with fingers only. In aggravated cases, replace packing. To correct cause (2), remove fluid nozzle (F), clean back of nozzle and nozzle seat in gun body using rag wet with thinner, replace nozzle and draw up tightly against body. To correct cause (3), tighten or replace swivel nut.

SPRAY GUN CLEANING INSTRUCTIONS

In certain states it is now against the law to spray solvents containing Volatile Organic Compounds (VOC)'s into the atmosphere when cleaning a spray gun. In order to comply with these air quality laws Binks recommends one of the following two methods to clean your spray finishing equipment:

1. Spray solvent through the gun into a **closed system**. An enclosed unit or spray gun cleaning station condenses solvent vapors back into liquid form which prevents escape of VOC's into the atmosphere.
2. Place spray gun in a washer type cleaner. This system must totally enclose the spray gun, cups, nozzles and other parts during washing, rinsing and draining cycles. This type of unit must be able to flush solvent through the gun without releasing any VOC vapors into the atmosphere.

Additionally, open containers for storage or disposal of solvent or solvent-containing cloth or paper used for surface preparation and clean-up may not be used. Containers shall be nonabsorbent.

AIR AND FLUID NOZZLE CLEANING

A faulty spray pattern is often caused by improper cleaning resulting in dried materials around the material nozzle tip or in the air nozzle. Soak these parts in thinners to soften the dried material and remove with a brush or cloth.

⚠ CAUTION

Never use metal instruments to clean the air or material nozzles. These parts are carefully machined and any damage to them will cause faulty spray.

If either the air nozzle or fluid nozzle are damaged, these parts must be replaced before perfect spray can be obtained.

CLEANING GUN USED WITH 1 QUART CUP

Relieve pressure in the cup. Then, unscrew, empty and carefully rinse cup out with thinners. Place clean thinners in the cup and spray this through the gun until it is clean. Blow air through gun to dry it.

CLEANING GUN USED WITH PRESSURE CONTAINER

⚠ WARNING

Injection of material from the gun into the skin may result in serious personal injury. Shut off the air supply to the container and release the pressure on the container before attempting to clean the gun.

Hold a piece of cloth wadded in the hand over the gun nozzle and pull the trigger. The air will back up through the material nozzle and force the material out of the hose into the container. Empty container. Put enough thinners into the container to wash the hose and gun thoroughly and spray this through the gun until it is clean. Then blow out the material hose to dry it and remove all traces of material by attaching it to the air line.

CLEANING GUN USED WITH PAINT CIRCULATING SYSTEM

Shut off material supply and remove material hose from gun. Clean gun as used with siphon cup or pressure container or connect quick release on paint line solvent line. To ensure clean air to spray gun, use Binks oil and water extractor. See your Binks distributor for the correct model.

MAINTENANCE

TO REPLACE AIR VALVE AND SPINDLE ASSEMBLY

Remove material valve control knob (21), spring (18), and needle assembly (20). Unscrew housing (19), and remove spindle assembly (17) with springs (16 & 18), housings (15), and o-rings (14). Lubricate new o-rings with Gunners Mate. Assemble components using material needle. Place this assembly along with housing (19) into gun body and screw into position. Remove material needle (20) and tighten housing (19).

TO REPLACE NEEDLE SEAL AND GLAND ADAPTER IN FLUID INLET

Remove material valve control knob (21) and spring (18) and pull out fluid needle (20). Unscrew packing nut (30) and remove spring (29) and seal backup (28). Using a no. 10 x 1-1/4" coarse-thread wood screw (Binks Part No. 20-6536) or small sheet metal screw, remove the needle seal (27) and gland adapter (26). Replace gland adapter (26) and needle seal (27). Re-insert seal backup (28) spring (29) and screw on packing nut (30) a couple of turns so it fits loosely by hand. Reassemble fluid needle (20), spring (18) and material valve control knob (21). Finally, tighten packing nut (30) until it bottoms out on fluid inlet (25).

LUBRICATION

Lubricate daily, all moving parts including trigger pivot point and air valve spindle and with Binks Gunners Mate (44).

Binks Model 95 SPRAY GUN

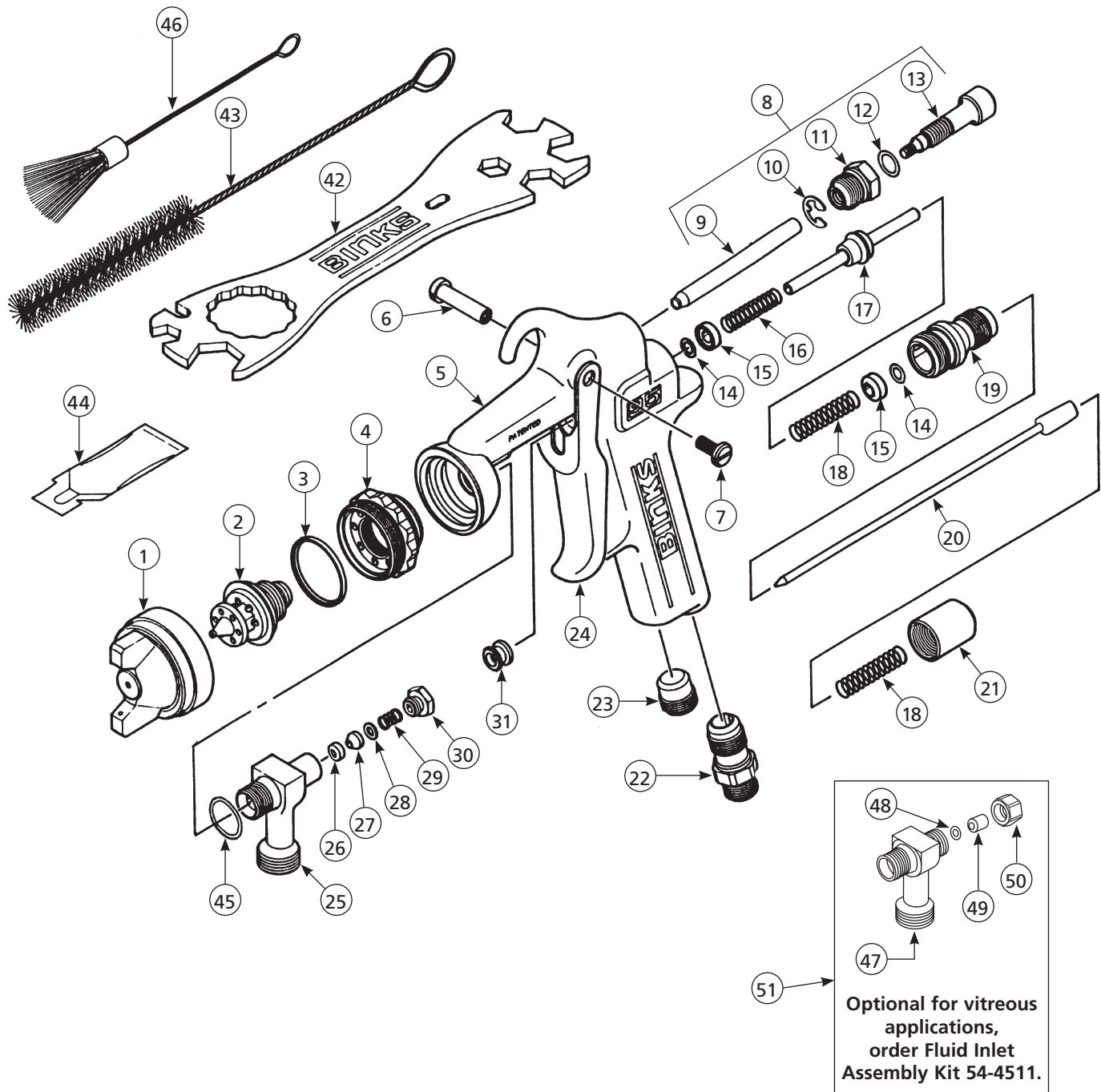

PARTS LIST

(When ordering, please specify Part No.)

ITEM NO.	PART NO.	DESCRIPTION	QTY.	ITEM NO.	PART NO.	DESCRIPTION	QTY.
1	*	AIR CAP ASSEMBLY.....	1	23	54-3504	PLUG.....	1
2	*	FLUID NOZZLE (Stainless Only).....	1	24	54-3578	TRIGGER.....	1
3	54-918●■^	SEALING RING.....	1	25	54-4210	FLUID INLET.....	1
4	54-4215	HEAD INSERT.....	1	26	54-4264●■	GLAND ADAPTER.....	-
5	—	95 SERIES GUN HANDLE.....	1	27	54-4265●■	NEEDLE SEAL.....	-
6	54-3580	TRIGGER STUD.....	1	28	54-4266●■	SEAL BACKUP.....	-
7	54-3581	TRIGGER SCREW.....	1	29	54-4267●■	SPRING.....	-
8	54-4216	SIDE PORT CONTROL ASSEMBLY.....	1	30	54-4263●■	PACKING NUT.....	-
9	54-4219	CONTROL STEM.....	-	31	54-3513	VALVE SPINDLE CAP.....	1
10	54-3511■	RETAINING RING.....	-	43	82-469	GUN BRUSH.....	1
11	54-4218	CONTROL BODY.....	-	44	—	GUNNERS MATE (3cc).....	1
12	20-6160■◆	O-RING.....	-	45	54-3592●■	COPPER GASKET.....	1
13	54-4217	CONTROL SCREW.....	-	OPTIONAL ACCESSORIES (Please order separately)			
14	20-4615■◆^	O-RING.....	2	42	54-4213	WRENCH (Optional).....	1
15	54-3515	HOUSING.....	2	46	OMX-88	GUN BRUSH (Optional).....	1
16	54-3520■◆	SPRING (Yellow).....	1	—	6-429	GUNNERS MATE (20 ea. 2 oz. bottles).....	1
17	54-3512■◆	SPINDLE ASSEMBLY.....	1	OPTIONAL SPRINGS (Please order separately)			
18	54-3518■◆	SPRING (Blue – 6 lbs., 8 oz.).....	2	18	54-4427	HEAVY DUTY SPRING (29 lbs.).....	1
19	54-3541	HOUSING.....	1				
20	*	FLUID NEEDLE (Stainless Only).....	1				
21	54-3606	MATERIAL VALVE CONTROL KNOB....	1				
22	54-768	AIR CONNECTION.....	1				

- * See Air Cap, Fluid Nozzle, and Needle Selection Chart page 8.
- Part of Repair Kit 54-3577 (Fluid Inlet and Air Valve Kit). Available only as a part of its assembly.
- Part of Repair Kit 54-4225 (Fluid Inlet Packing Kit).
- ◆ Part of Repair Kit 54-4226 (Air Valve Spindle Kit).
- ^ Part available separately in package of 5 (add -5 to part number).

FOR VITREOUS APPLICATIONS – PLEASE ORDER SEPARATELY

ITEM NO.	PART NO.	DESCRIPTION	QTY.	ITEM NO.	PART NO.	DESCRIPTION	QTY.
47	54-4568▲	FLUID INLET.....	1	49	54-4531▲●■	PACKING SPACER.....	1
48	20-2227-5▲●■†	O-RING.....	1	50	54-4542▲	NUT ASSEMBLY.....	1
				51	54-4511▲	FLUID INLET ASSEMBLY (VITREOUS)...	1

- ▲ Part of Fluid Inlet Assembly Kit 54-4511 (optional for vitreous applications).
- Part of Repair Kit 54-4225 (Fluid Inlet Packing Kit).
- Part of Repair Kit 54-3577 (Fluid Inlet and Air Valve Kit). Available only as a part of its assembly.
- †Part available separately in package of 5.

SEE PAGE 8 FOR OPTIONAL NOZZLE SETUPS

NOZZLE and NEEDLE SELECTION CHARTS

TYPE OF FLUID TO BE SPRAYED	FLUID X AIR NOZZLES	NOZZLE TYPE	CFM AT			MAX PATTERN AT 8"	FLUID NEEDLE NOS. FOR SPRAY GUN MODEL 95	FLUID NEEDLE PART NO. MODEL 95
			30 PSI	50 PSI	70 PSI			
VERY THIN 14-16 secs. Zahn 2 Cup Wash primers, dyes, stains, solvents, water, inks	63ss x 63P	PE	4.5	7.5	10.0	5	663	47-66300
	63Bss x 63PB	PE	9.0	14.3	20.0	14	663A	47-66310
	66ss x 66SD	SE	7.9	12.1	—	10.5	665	47-66500
	66ss x 66SK	SE	11.0	15.2	19.5	13	665	47-66500
	63Bss x 200	PI	3.1	5.2	6.4	12	663A	47-66310
THIN 16-20 secs. Zahn 2 Cup Sealer, lacquers, primers, inks, lubricants, zinc chromates, acrylics	63Ass x 63P	PE	5.1	8.37	12.2	11	663A	47-66310
	66ss x 66SK	SE	11.0	15.2	19.5	13	665	47-66500
	63Bss x 200	PI	3.1	5.2	6.4	12	663A	47-66310
MEDIUM 19-30 secs. Zahn 2 Cup Synthetic enamels, varnishes, shellacs, fillers, primers, epoxies, urethanes, lubricants, wax emulsions, enamels	63Bss x 63PB	PE	9.0	14.3	20.0	14	663A	47-66310
	66ss x 66SD	SE	7.9	12.1	—	11	665	47-66500
	66ss x 66SK	SE	11.0	15.2	19.5	13	665	47-66500
	63Css x 200	PI	3.1	5.2	6.4	12	663A	47-66310
HEAVY (Cream-like) Over 28 secs. No. 4 Ford Cup	67ss x 67PB	PE	9.5	14.9	19.5	12	667	47-66700
	68ss x 68PB	PE	9.5	14.1	19.1	12	668	47-66800
	67ss x 206	PI	6.0	9.5	13.0	15	667	47-66700
VERY HEAVY Texture coatings, Road marking paint	68ss x 68PB	PE	9.5	14.1	19.1	12	668	47-66800
	68ss x 206	PI	6.2	9.8	13.2	15	668	47-66800
	59Ass x 244	PI	7.8	11.5	15.2	12	659	47-65900
	59Ass x 245	PI	7.8	11.5	15.2	6	659	47-65900
	59Bss x 251	PI	7.8	11.5	15.2	12	659	47-65900
	59Bss x 252	PI	7.8	11.5	15.2	6	659	47-65900
	59Css x 262	PI	7.3	11.0	14.7	6	659	47-65900
	68ss x 206	PI	6.2	9.8	13.2	15	668	47-66800
ADHESIVES Waterbase white vinyl glues Solvent base, neoprenes (contact cement)	63Bss x 66SD-3	PE	7.9	12.1	16.2	4	663	47-66300
	67ss x 67PB	PE	9.5	14.1	19.1	12	667	47-66700
	66ss x 66SD-3	PE	7.9	12.1	16.2	10	665	47-66500
	66ss x 66SDJG	PE	10.4	—	—	8-9	665	47-66500
	66ss x 66R	PE/SE	—	4.2	—	RD	665	47-66500
	L6SS x 66SD-3	PE	9.5	14.2	19.0	10	665	47-66500
	L3BSS x 66SD-3	PE	9.5	14.2	19.0	10	663A	47-66310
CERAMICS Similar abrasive materials, glazes, engobes, porcelain enamel	67VT x 67PD	PE	10.0	15.0	20.0	15	667VT	47-66702
	68VT x 68PB	PE	9.5	14.1	19.1	12	668VT	47-66802
BUFFING COMPOUNDS	64VT x 64PA	PE	12.1	15.0	21.0	13	664VT (OBS)	47-66402 (OBS)
	67VT x 67PD	PE	10.0	15.0	20.0	15	667VT	47-66702
CONCRETE CURING COMPOUNDS	66ss x 200	PI	3.1	5.2	6.4	15	665	47-66500
	67ss x 206	PI	6.0	9.5	13.0	18	667	47-66700
	68ss x 206	PI	6.2	9.8	13.2	20	668	47-66800
MULTICOLOR PAINTS	66ss x 200	PI	3.1	5.2	—	12	665	47-66500
	67ss x 206	PI	6.0	9.5	—	15	667	47-66700
	66ss x R3	PI	—	4.2	—	FAN	665	47-66500
	66ss x R8	PI	—	4.2	—	FAN	665	47-66500
PTFE	63Ass x 63PB	PE	9.0	14.3	20.1	10	663A	47-66310
	66ss x 66SD	PE	7.9	12.1	—	7	665	47-66500
HAMMERS	63ss X 63PB	PE	9.0	14.3	—	14	663A	47-66310
	66ss X 63PB	PE	9.0	14.3	—	14	665	47-66500
	66ss X 66SD	PE	7.9	12.1	—	7	665	47-66500
WRINKLE ENAMELS	63Css x 63PB	PE	9.0	14.3	20.0	10	663A	47-66310
	66ss x 63PB	PE	9.0	14.3	20.0	10	665	47-66500
ZINC RICH COATINGS	66ss x 67PD	PE	12.0	18.0	24.0	15	665N (OBS)	47-66501 (OBS)
	67VT x 67PB	PE	9.5	14.1	19.1	12	667VT	47-66702

Note: PE - Pressure External SP - Siphon External PI - Pressure Internal

PART No.	45-5911	45-5912	45-5913	45-6301	45-6311	45-6321	45-6331	45-6501	45-6601	45-6701	45-6801
Nozzle No.	59ASS	59BSS	59CSS	63SS	63ASS	63BSS	63CSS	65SS	66SS	67SS	68SS
Orifice Size (in.)	.171	.218	.281	.028	.040	.046	.052	.059	.070	.086	.110
Orifice Size (mm)	4.3	5.5	7.1	0.8	1.1	1.2	1.3	1.6	1.8	2.2	2.8

SPECIAL NOZZLES – INTERNAL MIX HEAVY MATERIAL
SEE CHART AIR & FLUID NOZZLES

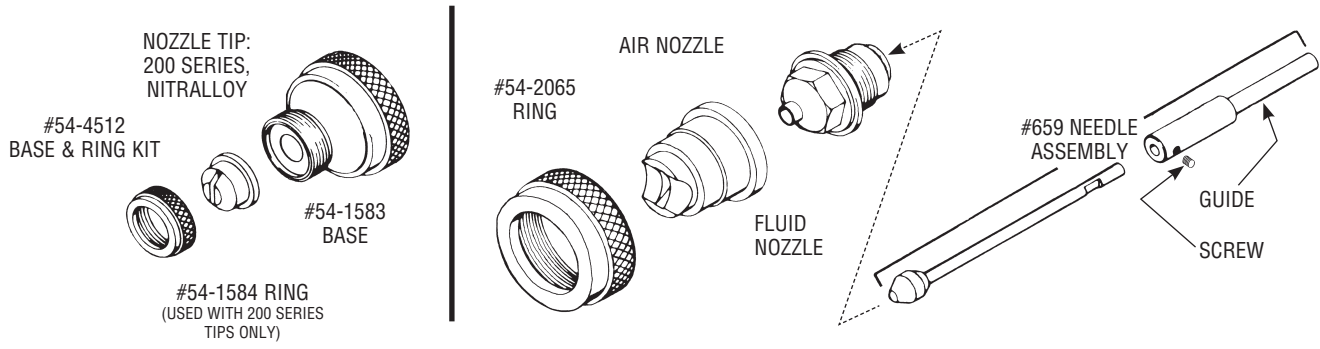

SPECIAL NOZZLE – CLEANING

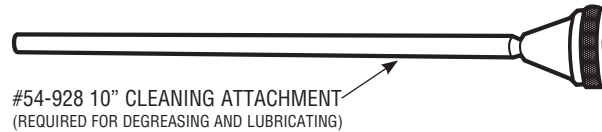

AIR CAP CHART

AIR CAP	NOZZLE TYPE	PART NO.	CFM @ 30 PSI	CFM @ 50 PSI	CFM @ 70 PSI	MAX. PATTERN WIDTH @ 8"
63PR	PE	46-6079	9.5	15.5	19.5	18"
64PA	PE	46-6007	12.1	15.0	21.0	13"
66PE	PE	46-6014		15.0		13"
66PH	PE	46-6016	11.5	16.4	22.0	13"
66R	PE	46-6041	5.0 CFM @ 50 PSI			Round Spatter
66S	SE	46-6018	3.4	5.0	—	9"
66SD	SE	46-6020	7.9	12.1	—	7–12"
66SD-3	SE	46-6092	10.4	15.4	20.4	9"
66SDJG	PE	46-6103	10.4			8–9"
66SK	SE	46-6082	11.0	15.2	19.5	13"
67PB	PE	46-6026	9.5	14.9	19.5	12"
67PD	PE	46-6028	10.0	15.0	20.0	15"
68PB	PE	46-6032	9.5	14.1	19.1	12"

SPECIALTY 200 SERIES INTERNAL MIX AIR CAPS

AIR CAP	NOZZLE TYPE	PART NO.	ADDITIONAL REQUIRED PARTS	MAX CFM @ 70 PSI	MAX. PATTERN WIDTH
200	PI	46-2200	54-4512 BASE & RING	6.4	12"
201		46-2201		9.1	11"
206		46-2206		13	15"
242		46-2242		8.2	RD
244		46-2244		15.2	
250		46-2250		14.7	
252		46-2252		15.2	6"
262		46-2262		14.7	

NOTES

NOTES

WARRANTY POLICY

Binks products are covered by Carlisle Fluid Technologies one year materials and workmanship limited warranty. The use of any parts or accessories, from a source other than Carlisle Fluid Technologies, will void all warranties. For specific warranty information please contact the closest Carlisle Fluid Technologies location listed below.

Carlisle Fluid Technologies reserves the right to modify equipment specifications without prior notice. DeVilbiss®, Ransburg®, MS®, BGK®, and Binks® are registered trademarks of Carlisle Fluid Technologies, Inc. ©2016 Carlisle Fluid Technologies, Inc. All rights reserved.



Binks is part of Carlisle Fluid Technologies, a global leader in innovative finishing technologies. For technical assistance or to locate an authorized distributor, contact one of our international sales and customer support locations.

USA/Canada

info@carlisleleft.com
Tel: 1-888-992-4657
Fax: 1-888-246-5732

Mexico

ventas@carlisleleft.com.mx
Tel: 011 52 55 5321 2300
Fax: 011 52 55 5310 4790

Brazil

vendas@carlisleleft.com.br
Tel: +55 11 5641 2776
Fax: 55 11 5641 1256

United Kingdom

info@carlisleleft.eu
Tel: +44 (0)1202 571 111
Fax: +44 (0)1202 573 488

France

info@carlisleleft.eu
Tel: +33(0)475 75 27 00
Fax: +33(0)475 75 27 59

Germany

info@carlisleleft.eu
Tel: +49 (0) 6074 403 1
Fax: +49 (0) 6074 403 281

China

mkt@carlisleleft.com.cn
Tel: +8621-3373 0108
Fax: +8621-3373 0308

Japan

overseas-sales@carlisleleft.co.jp
Tel: 081 45 785 6421
Fax: 081 45 785 6517

Australia

sales@carlisleleft.com.au
Tel: +61 (0) 2 8525 7555
Fax: +61 (0) 2 8525 7575

For the latest information about our products, visit www.carlisleleft.com.

